

REVISIONS			
REV	DESCRIPTION	DATE	APPROVED
-	-	-	-

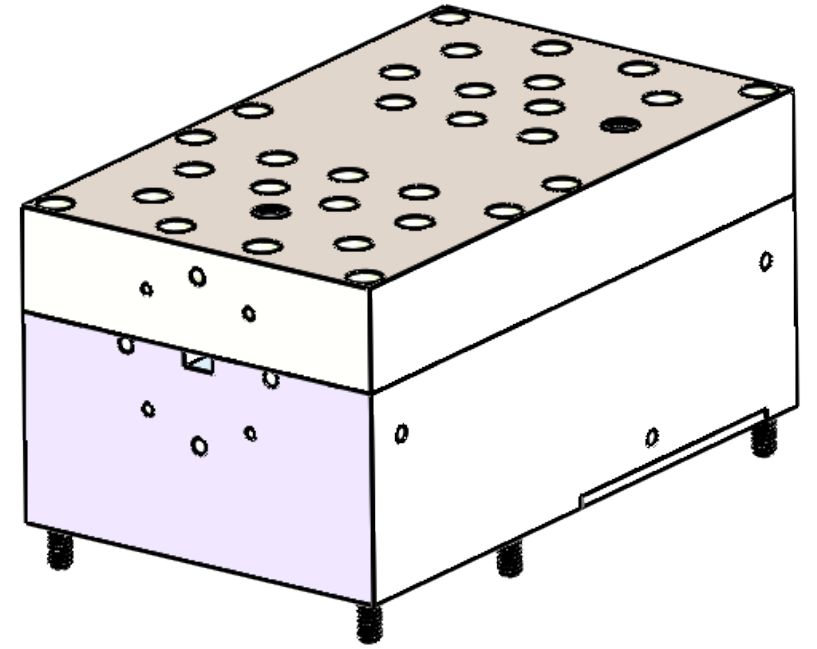

UG-383

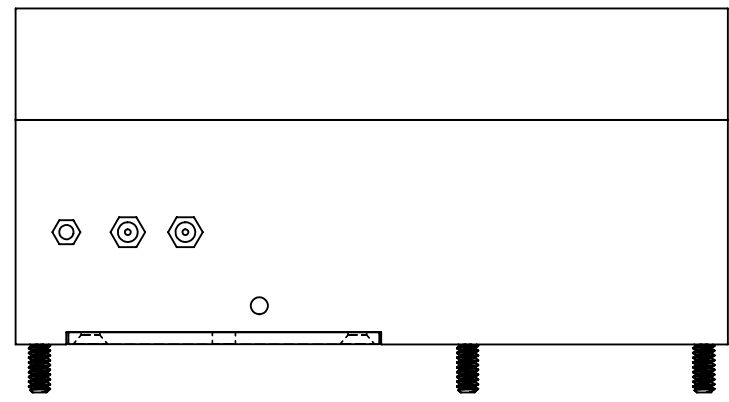
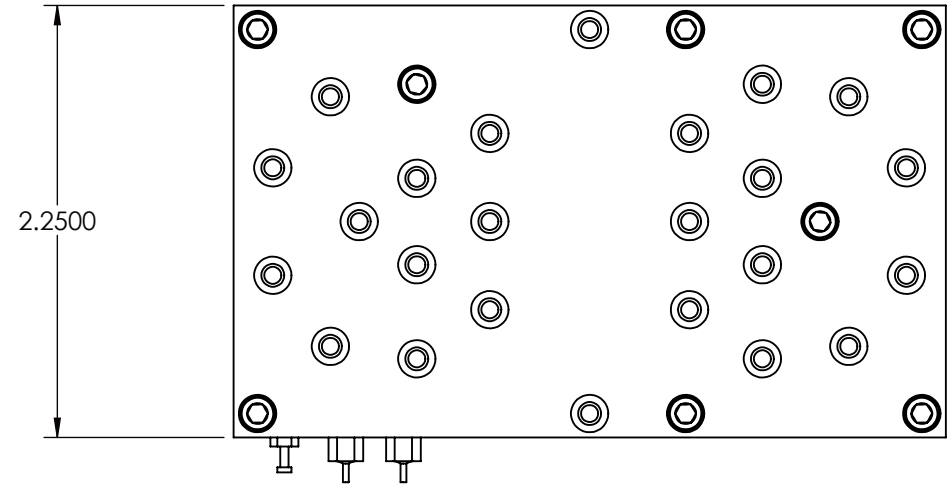
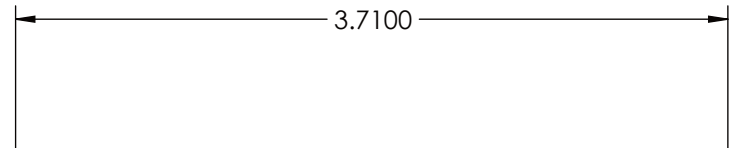
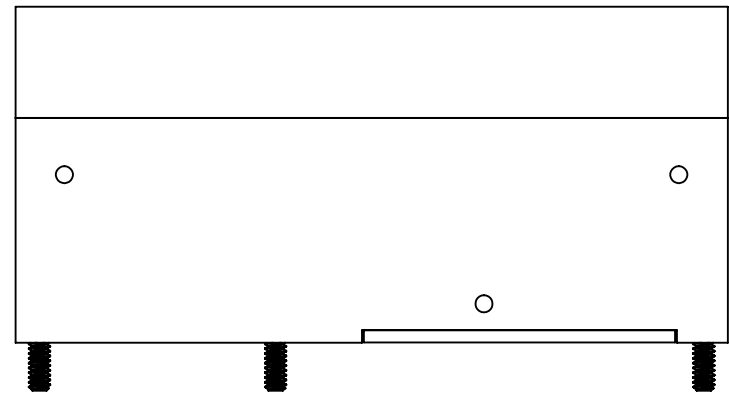
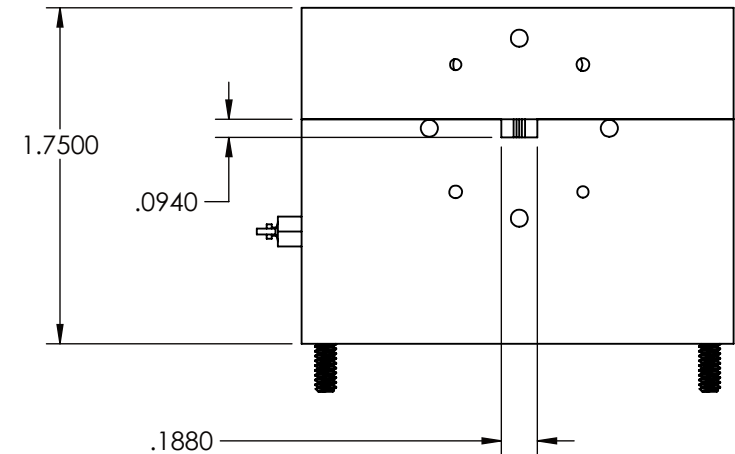

UG-383

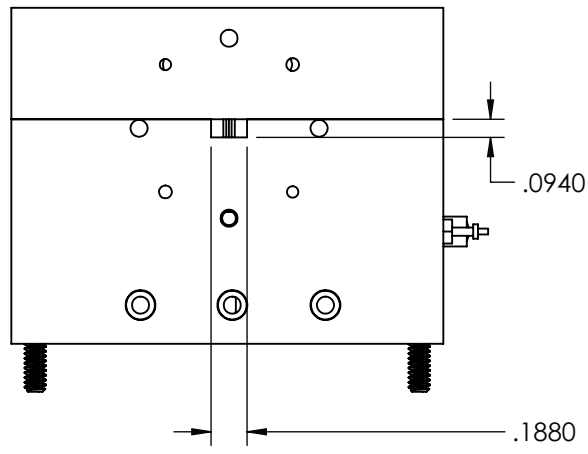

DECIMALS: XXXX ±.0005 XXX ±.005 XX ±.01	NAME: JV DATE: 2-20-20	TITLE: Millimeter Wave Products Inc.
ANGLES: ±.5 DEGREE	CHECKED: LS DATE: 2-20-20	SIZE: B
THIRD ANGLE PROJECTION	ENG: LS DATE: 2-20-20	DWG. NO. 955U_HPA_383_OUTLINE_25452
MATL: 6061 T6 ALUMINUM	SCALE: 1:1	WEIGHT:
		REV: -
		SHEET 1 OF 1